



RK-YKK15
温控電熱水壺
Temperature Control Kettle



僅供家庭使用
For household use only

使用說明書 OPERATION MANUAL

- 在使用本產品前，請仔細閱讀此說明書，閱讀後小心收藏保存，以備日後查閱。
Please read the operation manual carefully before using. Keep it in a safe place for future reference.
- 本說明書中的圖示可能與實物有不同的地方，僅供參考。
The images in this operation manual are for reference only and may not match with the actual product.

非常感謝您選購樂信牌溫控電熱水壺，使用前請先詳細閱讀本說明書，並保存以備日後參考。

目錄

1. 安全注意事項
2. 清潔及儲存
3. 產品規格
4. 產品說明
5. 首次使用
6. 使用方法
7. 特別聲明
8. 售後服務

1. 安全注意事項

使用本產品時，必須遵守下列安全措施。

下圖表示由於錯誤操作而引起不同程度的危險等級。

 警告 此標誌表示可能造成傷亡。	 注意 此標誌表示可能造成傷害或財物損失。
---	--

以下不同標誌區分各種必須遵守的指示。

 此標誌表示禁止。	 此標誌表示必須遵守。
---	---

警告

- | | |
|---|---|
|  為免危險，產品只適用於本說明書註明的用途。切勿將產品或任何部份在室外使用或作其他用途使用。如錯誤操作，可造成傷害。 |  切勿擅自改裝產品或使用非生產商提供的原廠零件進行修理，否則可造成危險及維修保養無效。 |
|  電熱水壺主體必須與原裝電源底座配合使用。使用前，確保電源底座與主體已徹底連接，否則會因接觸不良導致產品異常發熱或損壞。 |  切勿與其他高功率的電器共用同一插座、超額使用電線拖板或使用220-240V以外的電源，以防電力負荷過重及造成危險。 |
|  切勿從水龍頭或在洗滌槽中直接加水，避免水溢出至連接器或流入機內，或會造成電子零件故障或發生危險。 |  產品使用後必須清潔。切勿把產品、電源底座或插頭浸入水中；或被水濺濕，以免造成觸電及火災。 |
|  如使用自來水，須停用「Pure Water Mode」，將水煮沸至100°C，才可進行保溫。 |  切勿注水超過「MAX 1.5 L」最高水位標記。如果本產品裝水太多，沸騰時滾水可能噴出。 |
|  切勿使用有殘缺或鬆動的插座。 |  手濕時切勿接觸、插入或拔除插頭，否則可能構成觸電。 |
|  切勿讓兒童清潔及保養產品，除非兒童是年齡在8歲或以上及監督的情況下。監督兒童不可將產品當作玩具。將產品、電源底座及其電源線放於8歲以下兒童不能接觸的地方。 |  經常檢查產品、電源底座、電源線及插頭，如有損壞，為避免危險，應立即停止使用，並聯絡信興電器服務中心有限公司安排檢查及維修。 |

注意

-  電熱水壺只用來加熱開水，切勿加熱及盛載水以外的液體，如牛奶、茶或冰塊等。
-  電源底座可能會出現水珠凝結，這是正常現象，並不代表電熱水壺故障。
-  使用時，切勿移動或搖晃產品，以免造成危險。
-  切勿在加熱開水時將主體移離電源底座。
-  切勿使任何物件遮蓋產品表面及倒水口，避免過熱導致故障。
-  注水或倒水前，必須確保電熱水壺的電源已關閉，並將主體移離電源底座。
-  使用提手移動或提起主體，並應小心緩慢地倒出熱水，以免被燙傷。
-  在插入或拔除插頭時，應用手握穩插頭，不要抓住電源線。
-  不可放重物在電源線上；切勿夾住、改裝、用力拉扯或扭曲電源線。
-  使用前，確定產品表面、電源底座及插頭清潔乾爽，否則可能引致故障。
-  為避免燙傷，切勿將臉頰或手等靠近壺蓋及壺咀或觸碰變熱的電熱水壺表面；切勿觸摸使用後的發熱板，因仍有餘熱。
-  需時常留意水位，必須在水位低於「MIN 0.5 L」最低水位標記線前注水，避免引起產品乾燒。
-  在沸水過程中或剛沸騰後，切勿開啟壺蓋，否則有大量水蒸氣會冒出造成燙傷。打開壺蓋時，小心灼熱蒸氣及壺蓋有熱水滴落。
-  電熱水壺只供家庭或類似環境使用，如商戶內部、辦事處和其他工作環境的員工廚房區域；旅館、汽車旅館和其他住宿類似的環境。
-  切勿在以下環境使用電熱水壺：
 - 潮濕或近水的環境；
 - 被陽光直接照射或靠近熱源，如焗爐、電磁爐及火源；
 - 不平穩的表面上；
 - 易燃物料或不耐熱物品附近，(如枱布、窗簾及毛巾等)。
-  電熱水壺可供年齡在8歲或以上的兒童及體質、感覺或智力有障礙人士或缺乏經驗和相關知識的人士使用，但他們必須曾經接受負責安全人士的監督或指導如何安全地使用電熱水壺和理解所涉及之危險。
-  切勿在電源線纏結的情況下使用或將電源線懸掛在桌子、廚櫃的邊緣或讓它接觸發熱的表面，否則損害電源線。
-  使用後，必須拔出插頭然後倒清壺內的剩水。待電熱水壺冷卻後，才移動、清潔或檢查。

2. 清潔及儲存

1. 清潔前，必須先拔掉電源插頭及將主體與電源底座分離，並待產品冷卻。
2. 切勿用水沖洗產品。如要清潔機身表面，可用柔軟微濕布擦拭。若機身表面污漬太多，可用軟布沾上溫和清潔劑擦拭，然後再抹乾。
3. 使用後，產品內腔及發熱板可能會出現小斑點(如紅色、乳白色、黑色等情況)或變色。這個現象是由於水中所含的雜質引起變化或因水垢積聚太久所致。水的硬度越大，水垢積聚的速度越快。水垢可能會呈現不同的顏色。水垢雖然無害，但太多的水垢會影響產品的性能，須遵循指示定期清除產品內的水垢。
4. 清除水垢步驟：
 - 4.1. 將切片檸檬放入壺內，份量約為1至2片，或每升水放入20克檸檬酸。
 - 4.2. 注清水入壺內至「MAX 1.5 L」最高水位標記。
 - 4.3. 連接電源，把水加熱至沸騰後，讓產品冷卻15分鐘，再把熱水倒掉。混有檸檬片或檸檬酸的水，不可長時間浸泡在壺內，避免損壞內腔表面。
 - 4.4. 用海綿或軟毛刷刷洗內腔及發熱板，然後用清水沖洗乾淨。
 - 4.5. 再次注入清水加熱至沸騰，然後把熱水倒掉。
 - 4.6. 若壺內仍有殘餘水垢，可重覆以上步驟。
5. 如需清潔產品內腔及發熱板，用軟毛刷或海綿沾上溫和清潔劑清洗，再用水清潔乾淨。切勿使用去污粉或粗硬的潔具(如鋼絲刷)擦拭。
6. 切勿使用鹼性、含腐蝕性或有毒的清潔劑清潔產品。
7. 儲存時，將電源線收藏在電源底座，切勿將電源線纏繞在電源底座四周或壓住電源線，避免造成電源線損壞。
8. 儲存時，將產品放入紙箱及存放在乾爽的地方。

3. 產品規格

型號	RK-YKK15/*
顏色	* W = 象牙白 / B = 海軍藍 / G = 炭灰
額定電壓	220-240 伏特~ 50-60 赫茲
額定功率	1500-1800 瓦
容量 (約)	1.5 升
淨重 (約)	1.2 公斤
產品尺寸 (闊 x 深 x 高)	204 x 157 x 273 毫米

4. 產品說明

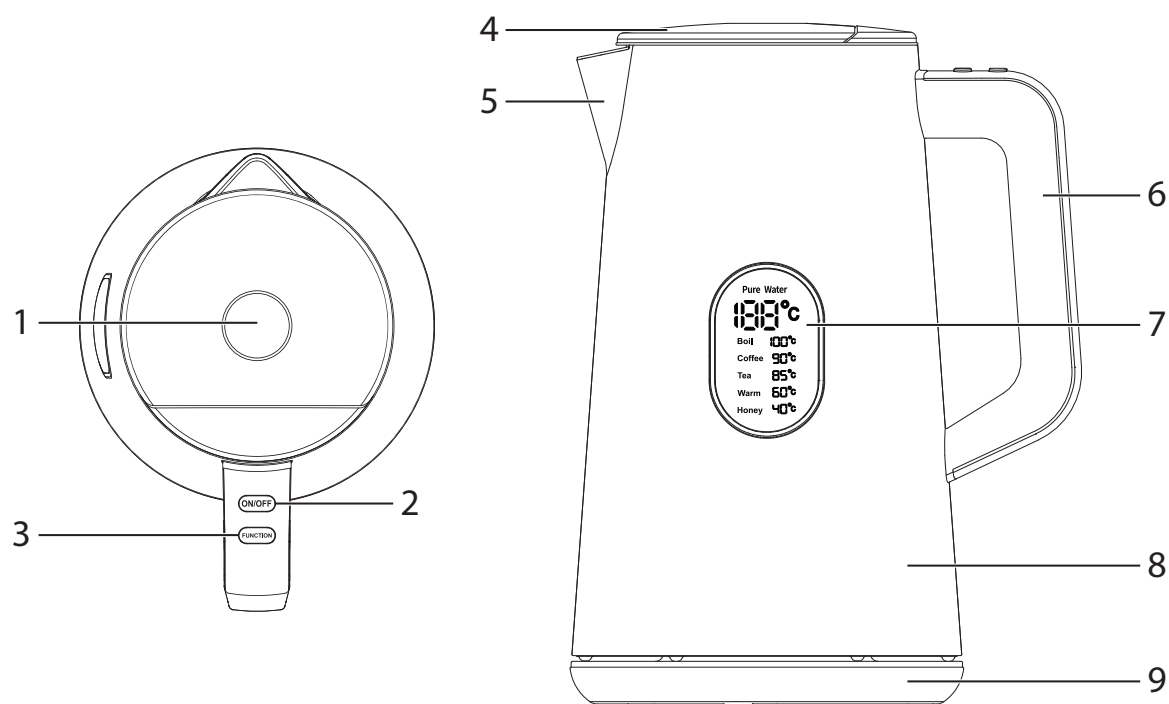

(產品圖像僅用作說明用途，可能與實際產品有所不同。)

- | | |
|---------|---------|
| 1. 開蓋按鈕 | 6. 手柄 |
| 2. 開關鍵 | 7. 顯示螢幕 |
| 3. 功能鍵 | 8. 主體 |
| 4. 壺蓋 | 9. 電源底座 |
| 5. 倒水口 | |

5. 首次使用

1. 清除產品的所有包裝物料及貼紙(如有)。
2. 將電源底座放置在乾燥及平穩的表面。
3. 將電源線從電源底座拉出至適當長度，將電源線穿過底座上的一個槽孔以固定其位置。
4. 用清水清洗產品內腔，然後加水到「MAX 1.5 L」最高水位標記，並將水煮沸一次(請參閱 6.使用方法)。
5. 將熱水倒掉並再次清洗產品內腔。

6. 使用方法

1. 如需注水入電熱水壺，將主體移離電源底座，然後按下開蓋按鈕，打開壺蓋。
2. 可使用自來水或蒸餾水。切勿注水低於水壺內標明的「MIN 0.5 L」最低或高於「MAX 1.5 L」最高水位標記，以免煮沸時乾燒或濺出熱水。當水位低於「MIN 0.5 L」水位標記時，切勿煮沸或保溫。
3. 關上壺蓋，直至聽見「喀嚓」一聲。
4. 將主體放在電源底座上，並將電源插頭插穩在電源插座上。

5. 按下開關鍵啟動電熱水壺。實時水溫和所有選項將在顯示螢幕上亮起，以顯示電熱水壺已開啟並處於待機模式。實時水溫溫度顯示隨實際環境有輕微變動，屬正常現象。

實時水溫溫度 °C

Boil 100 °C (煮沸)

Coffee 90 °C (咖啡)

Tea 85 °C (茶)

Warm 60 °C (保溫)

Honey 40 °C (蜜糖)

6. 如要煲水，按下功能鍵，選擇「**Boil 100 °C**」。電熱水壺便會將水煮沸(100 °C)，然後自動停止。電熱水壺及顯示螢幕會在閒置10分鐘後自動關機。

提示: 「**Boil 100 °C**」模式下沒有保溫功能。

7. 如要將熱水保存在理想的預設溫度(90/85/60/40 °C)：

水類	Pure Water Mode	100°C沸騰
自來水	停用	是
蒸餾水或白開水	啓動	否

- 7.1 如您使用自來水，按功能鍵2秒以停用「**Pure Water Mode**」(預設開啟)。如使用蒸餾水，可跳至下一步。停用該模式時，「**Pure Water**」的指示燈將在顯示螢幕上熄滅。如要重啟，再次按下功能鍵2秒。

- 7.2 然後重覆按功能鍵以選擇所需的預設溫度。當電熱水壺在加熱時，顯示螢幕上所選溫度的功能名將閃動，達至該溫度後將停止閃動。當前水溫將顯示在螢幕上。

- 如您使用自來水，須停用「**Pure Water Mode**」。當在此模式停用時選擇90/85/60/40 °C水溫，電熱水壺會將水加熱至100 °C，然後發出嗶聲。電熱水壺會自動將水保溫至所選擇的溫度，最長24小時之後便會關機。
- 如您使用蒸餾水或白開水，可啟用「**Pure Water Mode**」。當在此模式啓用時選擇90/85/60/40 °C水溫，電熱水壺會將水加熱至所選擇的溫度，然後發出嗶聲。電熱水壺會自動將水保溫至所選擇的溫度，最長24小時，然後便會關機。

提示: 在保溫功能下，如將主體從電源底座提起，再重新放回底座，電熱水壺會繼續原來的保溫設定。

8. 使用後，按下開關鍵關機，並拔出電源插頭。

⚠注意:

- 如使用自來水，將水煮沸至100 °C，然後才進行保溫。
- 為避免燙傷，只可觸碰按鈕及用手柄提起電熱水壺。
- 如不使用產品，必須關掉電源並拔出電源插頭。

提示: 此產品設有防乾燒功能。若產品在沒有盛水或水量低於「**MIN 0.5 L**」最低水位標記的情況下運作，產品會自動關機。若產品曾乾燒，須先關掉電源，並將產品移離電源底座，待其冷卻15分鐘後，才再次使用。

7. 特別聲明

1. 此說明書內所有內容經過核對，如有任何印刷錯誤或內容上的誤解，本公司將保留解釋權。
2. 本產品若有技術改進，會編進新版說明書中，恕不另行通知；產品外觀及規格以廠方生產資料為準。
3. 此說明書的電子副本可透過電子郵件發送致客戶。如有需要，請致電信興電工工程有限公司: 2861 2767。

8. 售後服務

信興電工工程有限公司(「本公司」)將授權信興電器服務中心有限公司(「服務中心」)(統稱「信興」)提供一年保修服務並由發票/換購收據上的日期起計。超過這期間者，客戶須按服務中心的修理服務價目表繳付一切費用。

1. 信興對於任何因產品不適當地使用或任何產品之故障、損壞或停頓而引致任何人士或財產的直接或間接損失及破壞，概不負責。
2. 客戶須自行將產品送往客戶服務中心或市區內，並於產品修妥後於同一地點取回。
3. 保修卡(印在包裝盒上)只適用於香港及澳門。於修理時，客戶需出示保修卡及由香港或澳門經銷商發出的正式發票/換購收據予技術員查閱。保修卡上之產品型號必須與機身相符，保修卡上之購買日期須與正式發票/換購收據上的日期符合，方為有效。除指定保修卡外，任何商號及人士發出之保修卡，均不為信興認可。
4. 客戶不可擅自更改產品上的機身編號，如發現產品上的機身編號與保修卡所列者不符，保修卡則告無效。(如適用)
5. 除產品表面、機殼、損耗性零件及附件外，產品如在保修期內發生故障，經服務中心證實乃在正常使用情況下發生者，服務中心將提供免費修理及更換零件服務，經更換後之任何損壞零件，將歸服務中心所有。
6. 下列項目並不包括於保修範圍內。客戶須另付所需的服務費用。(甲) 修理或更換產品之附件、外觀及損耗性零件，包括但不限於外接線、機殼、面板、面板貼紙等。(乙) 曾被非服務中心的技術員明顯地或不明顯地進行改裝、更改或修理的產品。(丙) 曾經被不適當或疏忽使用、不正常供電或電壓不正常、意外、天災或因昆蟲、外物、液體入侵、腐蝕或外來因素而造成損壞的產品。(丁) 因產品不正確安裝而影響正常之操作。
7. 如中英文版本有差異時，應以中文版為準。
8. 所有資料如有任何更改，恕不另行通知。如有任何爭議，服務中心保留最終決定權。
9. 保修卡沒有賦予或意圖賦予任何第三者因《合約(第三者權利)條例》(第623章)所列之任何利益或權利以強制執行保修卡的任何條款內容。



Thank you for choosing Rasonic temperature control kettle. Please read the operation manual carefully before use and well keep for your future reference.

Table of Contents



1. Important Safeguards
2. Cleaning and Storage
3. Product Specifications
4. Product Descriptions
5. Before First Use
6. Operation Instructions
7. Special Avowal
8. After Sales Service

1. Important Safeguards





When using the appliance, must follow the below basic safety precautions:
The following chart indicates the degree of damage caused by wrong operation.

 WARNING Indicates that may cause death or severe injury.	 CAUTION Indicates hazards that may cause human injuries or property damages.
--	--

The following symbols can distinguish the instruction types that need to be strictly followed.









 These symbols mean prohibition.	 These symbols mean requirement that must be followed.
--	--

 **WARNING**

 To avoid danger, use the appliance only as described in the operation manual. Do not use it or any part of the appliance outdoors or out of the intended purpose. Misuse can cause potential injury and malfunction.	 Do not attempt to modify the appliance by yourself or repair with any unauthorized parts, otherwise it can cause hazards and the warranty will become invalid.
 Only use the kettle with the original power base. Make sure that the power base and main body are well connected before use, otherwise it will cause the appliance overheat or damage due to contact failure.	 Do not use the same socket with other high power consumption appliance, use the extension unit beyond its capacity or use the power supply other than 220-240V~ to avoid danger caused by overload.















WARNING

-  Do not fill water directly from the tap or in a sink to avoid spillage on the connector or water getting into the appliance, it may cause electronic parts malfunction or danger.
-  Clean the appliance after use. Must not immerse the appliance, power base or plug in water or let them wet, it can cause electric shock and fire.
-  If you are using tap water, must deactivate **Pure Water Mode**, heat the water to a full boil (100 °C) before keeping it warm.
-  Do not add water exceed the maximum "**MAX 1.5 L**" level marked inside the appliance. If the appliance is overfilled, boiling water may be ejected.
-  Do not use deficient or loosen socket.
-  Do not touch, plug in or remove the plug with wet hand, it can cause electric shock.
-  Cleaning and user maintenance shall not be made by children unless they are aged from 8 years and above and supervised. Children being supervised not to play with the appliance. Keep the appliance, power base and its power cord out of children aged less than 8 years.
-  Always check the condition of the appliance, power base, and power cord and plug. If damage is found, stop using the appliance immediately to avoid hazard and contact Shun Hing Electric Service Centre Limited to check and repair.



CAUTION

-  The appliance is for boiling water only. Do not heat and contain any liquids other than water such as milk, tea or ice etc.
-  Condense water droplets may appear on the power base. This is normal and does not indicate the appliance malfunction.
-  Do not move or shake the appliance when in use, so as not to cause danger.
-  Never remove the main body from the power base during boiling water.
-  Do not cover the appliance surface and spout with any objects, so as not to cause overheat and malfunction.
-  Before filling or pouring water, ensure the appliance is switched off and the main body is separated from the power base.
-  Use the handle to move or lift the main body and pour out the hot water slowly to avoid burn.
-  Be sure to grasp the power plug when plug in or unplug the plug, do not grasp the power cord.
-  Do not place heavy objects on the power cord. Never clip, modify, stretch or twist the power cord.
-  Make sure the appliance surface, power base and plug is clean and dry before use, otherwise it may cause malfunction.
-  To avoid burn, never get your face or hands close to the lid or spout, or touch the housing which become hot; never touch the heating plate after use which is subject to residual heat.
-  Always pay attention to the water level. Make sure to refill water before the water is below the minimum "**MIN 0.5 L**" level marked inside the appliance to avoid boil-dry.



CAUTION



Do not open the lid during use or right after used. Otherwise, massive hot steam may come out from the steam vent. When open the lid, be careful of the hot steam and hot water droplets dripping from the lid.



Do not operate the appliance in the following places:

- Near humid environment or water;
- Expose to sunlight or near heat sources such as electric oven, induction cooker and fire;
- On unstable surface;
- Near inflammable or Non-resistant to heat objects (e.g. table cloth, curtain and towel etc.).



Do not operate the appliance when the power cord is tangle or hang the power cord over the edge of table, counter-top or let it touch any hot surface, it may damage power cord.



The appliance is intended to be used in household or similar applications such as staff kitchen in shops, offices and other working environments; by clients in hotels, motels and other residential type environments.



This appliance can be used by children aged from 8 years and above and persons with reduced physical, sensory or mental capabilities or lack of experience and knowledge, if they have been given supervision or instruction concerning use of the appliance in a safe way and understand the hazards involved.



After use, unplug the appliance from the power socket and then empty the appliance. Let the appliance cool down before moving, cleaning or checking.

2. Cleaning and Storage

1. Before cleaning, always unplug the appliance from the power socket, lift the main body from power base and let it cool down.
2. Do not rinse the appliance with water. To clean the appliance surface, use a slightly damp cloth. If it is too dirty, wipe with a damp cloth with mild detergent, then wipe them dry.
3. After use, some color spots (e.g. red, milky, black, etc.) and discolor may appear in the appliance cavity and heating plate. This is because of the impurities contained in water or the accumulated scale. The harder the water, the faster the scale will build up. Scale can occur in different colors. Although scale is harmless, too much scale can affect the performance of the appliance. To avoid this, descale the appliance regularly.
4. Descaling procedure:
 - 4.1 Put 1-2 pieces of sliced lemon or 20g citric acid for 1L water into the appliance.
 - 4.2 Fill clean water to the maximum "MAX 1.5 L" level marked inside the kettle.
 - 4.3 Connect the appliance with power source and let the water boil once. Cool down the appliance for 15 minutes after boiled, then empty the appliance. Water with sliced lemon or citric acid should not keep in the cavity for too long to prevent deteriorating the inner surface.
 - 4.4 Clean the cavity and heating plate with a sponge or soft brush, then rinse it with water.
 - 4.5 Fill water to boil again and then empty the appliance.
 - 4.6 Repeat the procedure if some scale remains in the cavity.
5. When clean the appliance cavity and heating plate, use soft brush or sponge moisten with mild detergent and rinse with clean water. Never use cleaning powder or harsh cleaning tools (e.g. metal-wired brush).
6. Never use alkaline, poisonous or corrosive detergent to clean the appliance.
7. When store, wind the power cord in the power base. Never wrap the power cord tightly around the power base or put pressure on it to avoid the power cord damage.
8. When store, put the appliance into a box and store it in a dry place.

3. Product Specifications

Model	RK-YKK15/*
Color	* W = Ivory white / B = Navy blue / G = Charcoal grey
Rated Voltage	220-240 V~ 50-60 Hz
Rated Power	1500-1800 W
Capacity (Approx.)	1.5 L
Net Weight (Approx.)	1.2 kg
Product Size (W x D x H)	204 x 157 x 273 mm

4. Product Descriptions

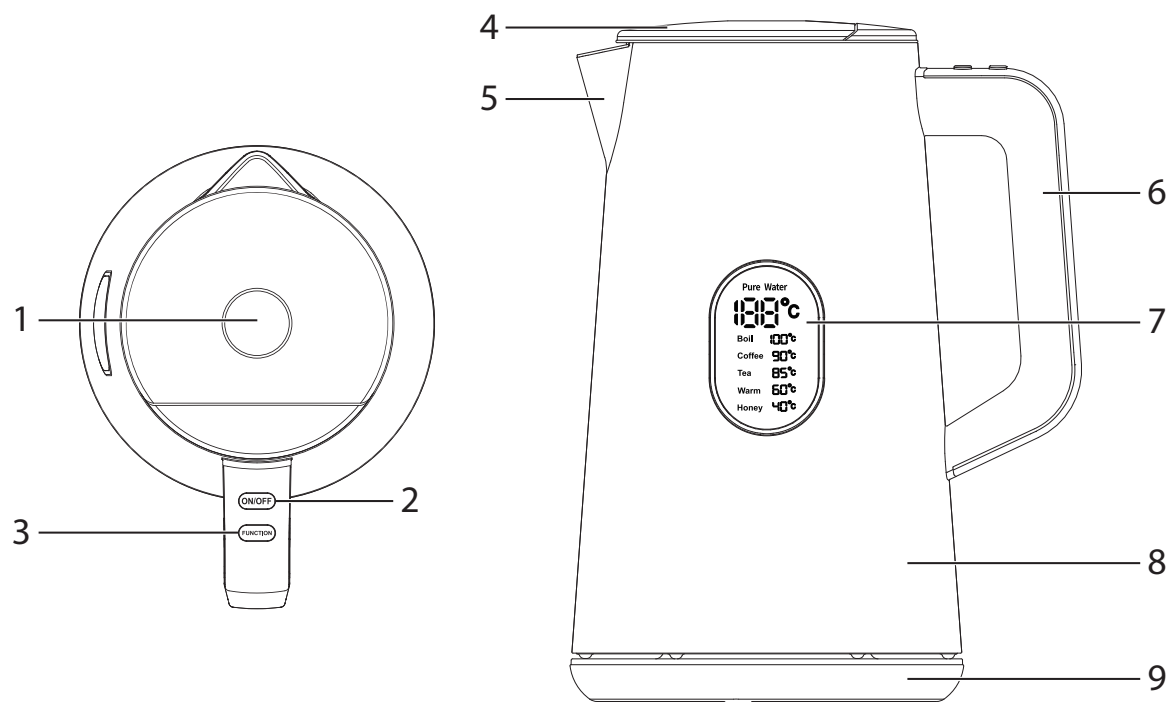

(Product images are for illustrative purpose only and may differ from the actual product.)

- | | |
|-----------------------|-------------------|
| 1. Lid release button | 6. Handle |
| 2. ON/OFF button | 7. Display screen |
| 3. FUNCTION button | 8. Main body |
| 4. Lid | 9. Power base |
| 5. Spout | |

5. Before First Use

1. Remove all the packing materials and stickers (if any) from the appliance.
2. Place the power base on a dry, stable and flat surface.
3. Unwind the power cord from the power base to suitable length. Pass the power cord through the slot of the power base to fix its position.
4. Rinse the appliance cavity with water. Then fill water to the maximum **"MAX 1.5 L"** level marked inside the kettle and let the water boil once (Refer to 6. Operation Instructions.)
5. Pour out the hot water and rinse the appliance cavity once more.

6. Operation Instructions

1. To fill the kettle, remove the main body from the power base and press the lid release button to open the lid.
2. Fill the kettle with tap water or distilled water. Do not fill below the minimum **"MIN 0.5 L"** or above the maximum **"MAX 1.5 L"** level marked inside the kettle to avoid boil-dry or hot spillage when boiling. Do not boil or keep warm when the water is below the **"MIN 0.5L"** level mark.
3. Close the lid by pressing it firmly until you hear a "click".
4. Place the main body on the power base and plug the power cord firmly into a wall socket.

- Press the ON/OFF button to turn the kettle on. The current water temperature and all options will illuminate on the display screen to indicate that the appliance is on and in standby mode. The current water temperature may be slightly changed according to the actual environment, which is normal.

(Current water temperature) °C

Boil 100 °C

Coffee 90 °C

Tea 85 °C

Warm 60 °C

Honey 40 °C

- To boil the water, press the FUNCTION button and select **"Boil 100 °C"**. The kettle will bring the water to a full boil (100 °C) and stop automatically. The kettle and display automatically turn off after idled 10 minutes.

NOTE: There is no keep warm function in **"Boil 100 °C"**.

- To keep warm at a desired preset temperature (**90/85/60/40 °C**):

Type of water	Pure Water Mode	Full boil 100°C
Tap water	Deactive	Yes
Distilled or pre-boiled water	Activate	No

7.1 If you are using tap water, press the FUNCTION button for 2 seconds to deactivate **Pure Water Mode** (activated by default). Or, skip to the next step if you are using distilled water. When the mode is deactivated, **"Pure Water"** will go off on the display screen. To re-activate, press the button for 2 seconds again.

7.2 Then, press the FUNCTION button repeatedly to select the desired preset temperature. The name of the selected temperature will blink while the kettle is heating up the water, and will stop blinking once the temperature is reached. The current water temperature will show on the display screen.

- Deactivate **Pure Water Mode** if you are using tap water. When **90/85/60/40 °C** is selected while the mode is deactivated, the kettle will heat the water to a full boil (100 °C) and beep. Then the kettle will automatically keep warm at the selected temperature for up to 24 hours and turn off.
- Activate **Pure Water Mode** if you are using distilled or pre-boiled water. When **90/85/60/40 °C** is selected under this mode, the kettle will heat the water up to the selected temperature and beep. Then the kettle will automatically keep warm at the selected temperature for up to 24 hours and turn off.

NOTE: During keep warm function, if the main body is removed from the power base and returned it afterward, the kettle will resume to the last keep warm setting.

- Once finished using the appliance, press the ON/OFF button to turn the appliance off and unplug the power plug from the wall socket.

⚠ CAUTION:

- Always bring tap water to a full boil (100 °C) before keeping it warm.
- To avoid burns, only touch the buttons and hold the kettle by the handle.
- Always turn off and unplug the appliance when it is not in use.

NOTE: The appliance is equipped with a boil-dry protection device. If it is boiled without water or the water below the minimum **"MIN 0.5 L"** level marked inside the kettle, it will automatically switch off. If the appliance was boiled dry before, switch it off and lift the main body from the power base. Let the appliance cool down for 15 minutes before use again.

7. Special Avowal

1. The content in the operation manual has been checked. Our company reserves the hermeneutic power to any printing errors or misunderstanding on the content.
2. If there are technical improvements on the appliance, the operation manual will be updated in new version without prior notice. The product appearance and specification are subject to the manufacturer information.
3. The e-copy of user manual can be sent by e-mail on requested. For enquiries, please call Shun Hing Electric Works & Engineering Co., Ltd. hotline at 2861 2767.

8. After Sales Service

Shun Hing Electric Works & Engineering Co., Ltd. ("The Company") authorizes Shun Hing Electric Service Centre Ltd. ("SHESC") (collectively "Shun Hing") to offer one year warranty service to the product commencing from the date of purchase invoice or redemption voucher. Services beyond the said warranty period will be charges according to the standard service charge price list from SHESC.

1. Shun Hing shall not be liable for any direct or indirect loss or damage to any person or property, howsoever caused arising from improper use, or any stoppage, breakdown or failure of the product.
2. Customer is responsible to deliver the product to our service station or any place in urban area, and to pick up the repaired product from the same location.
3. The warranty card (printed on the packing box) is valid only in Hong Kong and Macau. Customer is required to present the warranty card together with the official purchase invoice issued by the dealers of Hong Kong or Macau or redemption voucher to our technician for verification when service is rendered. The warranty card is valid only if the model number stated herein corresponds with that of the product and the date of purchase/redemption stated herein is the same with the date of official purchase invoice/redemption voucher. Save and except the specific warranty card, any other warranty card issued by other parties will not be recognized by Shun Hing.
4. Customer shall not alter the serial number of the product. The warranty card is void if the serial number on the product does not match with that shown on the warranty card (if applicable).
5. For any defect which in our judgment is caused under normal use, SHESC will repair or replace the defective parts, excluding any surface, cabinet, consumptive parts and accessories, free of charge within the warranty period. Any defective part which has been replaced shall become the property of SHESC.
6. Warranty service does not cover the following items. Additional charges shall be levied if services are required. (a) Repair or replacement of accessories, cosmetic and consumptive parts including but not limited to external cables, control panel, control panel label and etc. (b) The product has been explicitly or implicitly modified, tempered with, altered or repaired in any way by persons other than technicians of SHESC. (c) The product has been damaged through misuse, negligence, power interruption or abnormal voltage input, accident, natural calamities, or due to ingress of insects, foreign matters or liquid, corrosion or external factors. (d) The normal operation of the product is affected by improper installation of the product.
7. In case there is any inconsistency or conflict between English version and Chinese version of the terms, the Chinese version shall prevail.
8. All terms stated are subject to change without notice. SHESC retains final deciding authority in case of dispute.
9. Nothing in the warranty card confers or purports to confer on any third party any benefit or any right pursuant to the Contracts (Rights of Third Parties) Ordinance (Cap. 623) to enforce any term of the warranty card.



信興電工工程有限公司

SHUN HING ELECTRIC WORKS AND ENGINEERING CO., LTD.

辦公室：香港九龍尖沙咀東部麼地道67號半島中心9樓909-912室

電話：2861 2767

圖文傳真：2865 6706

網址：<http://www.rasonic.com>

電郵：shew@shunhinggroup.com

Office: Room 909-912,9/F., Peninsula Centre, 67 Mody Road, Tsimshatsui East, Kowloon, H.K.

Tel: 2861 2767

Fax: 2865 6706

Website: <http://www.rasonic.com>

E-mail: shew@shunhinggroup.com

保養及維修 Maintenance and Repair Service:

信興電器服務中心有限公司

SHUN HING ELECTRIC SERVICE CENTRE LTD.

香港新界葵涌勝耀街2號信興中心11樓

服務熱線：2406 5666

傳真號碼：2408 0316

網址：<http://www.shesc.com/zh>

11/F, Shun Hing Centre, 2 Shing Yiu Street, Kwai Chung, N.T., H.K.

Service Hotline: 2406 5666

Fax No.: 2408 0316

Website: <http://www.shesc.com/en>

客戶服務中心：

香港新界葵涌勝耀街2號信興中心1樓

九龍佐敦佐敦道23-29號新寶廣場20樓

香港天后琉璃街7號柏景中心22樓

澳門慕拉士大馬路193-199號南嶺工業大廈5樓I座

有關最新之香港及澳門客戶服務中心資料，請參閱信興服務中心網址：www.shesc.com。

Customer Service Centres:

1/F, Shun Hing Centre, 2 Shing Yiu Street, Kwai Chung, N.T., H.K.

20/F, Sino Cheer Plaza, 23-29 Jordan Road, Jordan, Kowloon, H.K.

22/F, Parkview Centre, 7 Lau Li Street, Tin Hau, H.K.

Avenida de Venceslau de Morais, No.193-199, 5 andar - I, Edf. Industrial Nam Leng, Macau

For the latest information of Hong Kong and Macau service center, please visit www.shesc.com.